

1

Calculer la surface du volet roulant en m².
 Multiplier la mesure de la base (en m) par la hauteur du volet roulant (en m)

*Calcular la superficie de la persiana en m².
 Multiplicar la dimensión de la base (expresada en metros) por la altura (expresada en metros)*

2

Calculer le poids indicatif du volet roulant
 Multiplier le résultat de la surface calculée au point 1 par le poids du matériel du volet roulant (en Kg/m²).

*Calcular el peso indicativo de la persiana.
 Multiplicar la superficie resultante en el punto 1 por el peso del material utilizado (expresado en Kg/m²).*

Matériel / Material	Poids / Peso (Kg/m ²)
Aluminium à haute densité de polyuréthane expansé Aluminio de alta densidad con espuma de poliuretano	3-9
Aluminium extrudé - Aluminio extruido	7-12
PVC	5-10
Acier - Acero	8-12
Acier Sicurfer blindé - Acero Sicurfer blindado	15-20
Bois - Madera	10-12

3

Déterminer le moteur à utiliser
 Choisir la ligne correspondant au dimension du tube de votre volet, en croisant le poids du volet reporté dans la partie supérieure du tableau. Exemple: pour une volet de 55 Kg avec un tube de 70 mm de diamètre, il sera nécessaire d'utiliser le EURODRIVE 40

*Individuar el motor a utilizar.
 Elegir el reglón correspondiente a la dimensión del tubo enrollable cruzando el peso de la persiana que está colocado alto en la tabla. Ejemplo: para una persiana de 55 Kg montada en un tubo enrollable de 70 mm de diámetro, se debe utilizar el EURODRIVE 40.*

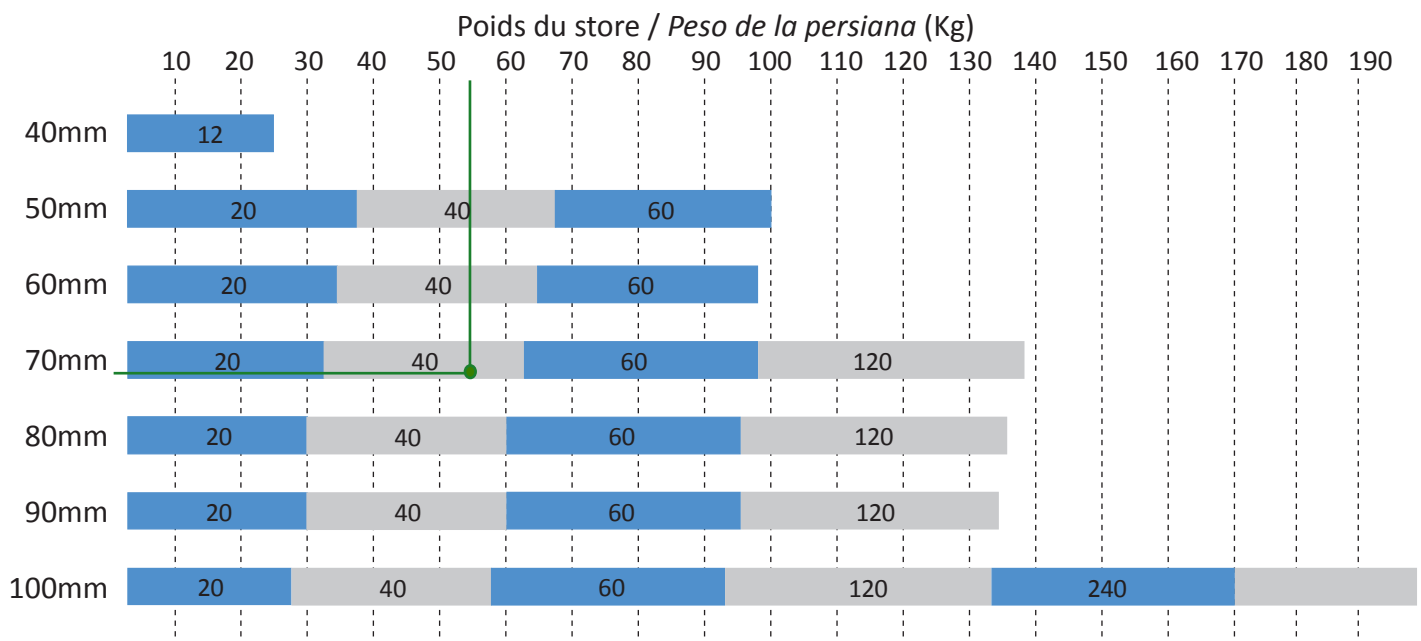

Note: il faut considérer la possible déformation du tube de manière à garantir un fonctionnement correct et durable du moteur.
 Nota: considerar la posibilidad de deformaciones del tubo enrollable para garantizar el correcto y duradero funcionamiento del motor.

Série EURODRIVE – Accessoires / Serie EURODRIVE – Accesorios

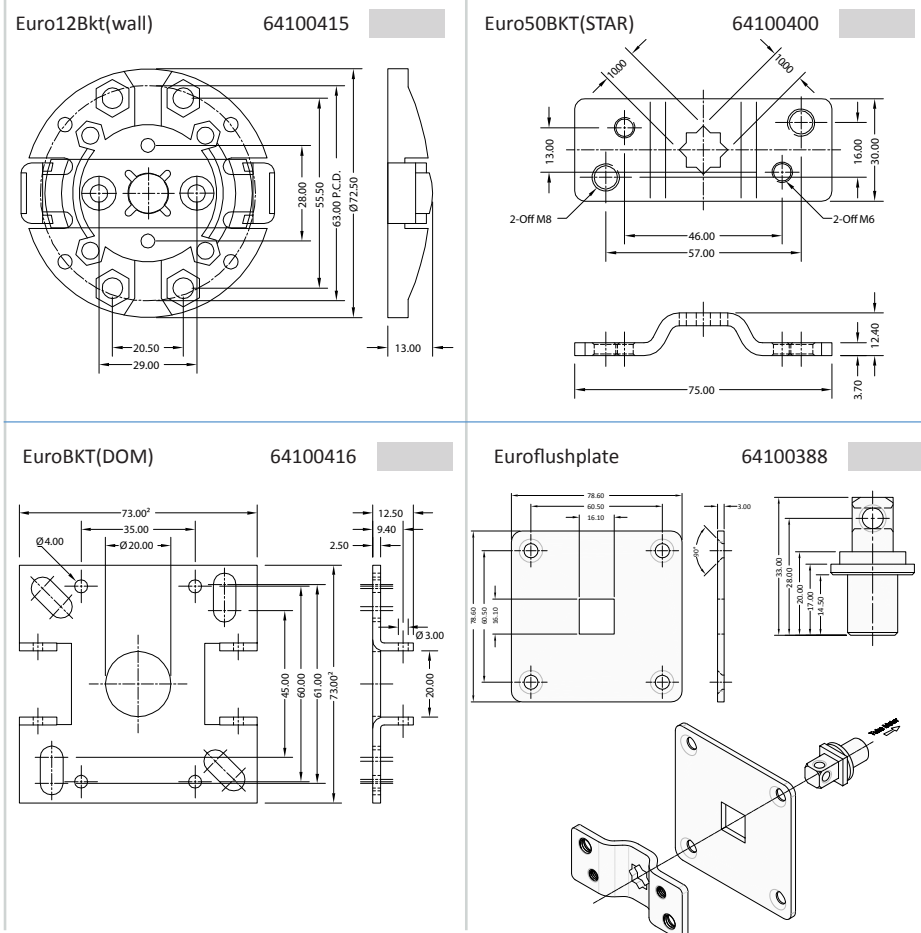

Série EUROTEC & EUROPLUS – Accessoires / Serie EUROTEC & EUROPLUS – Accesorios

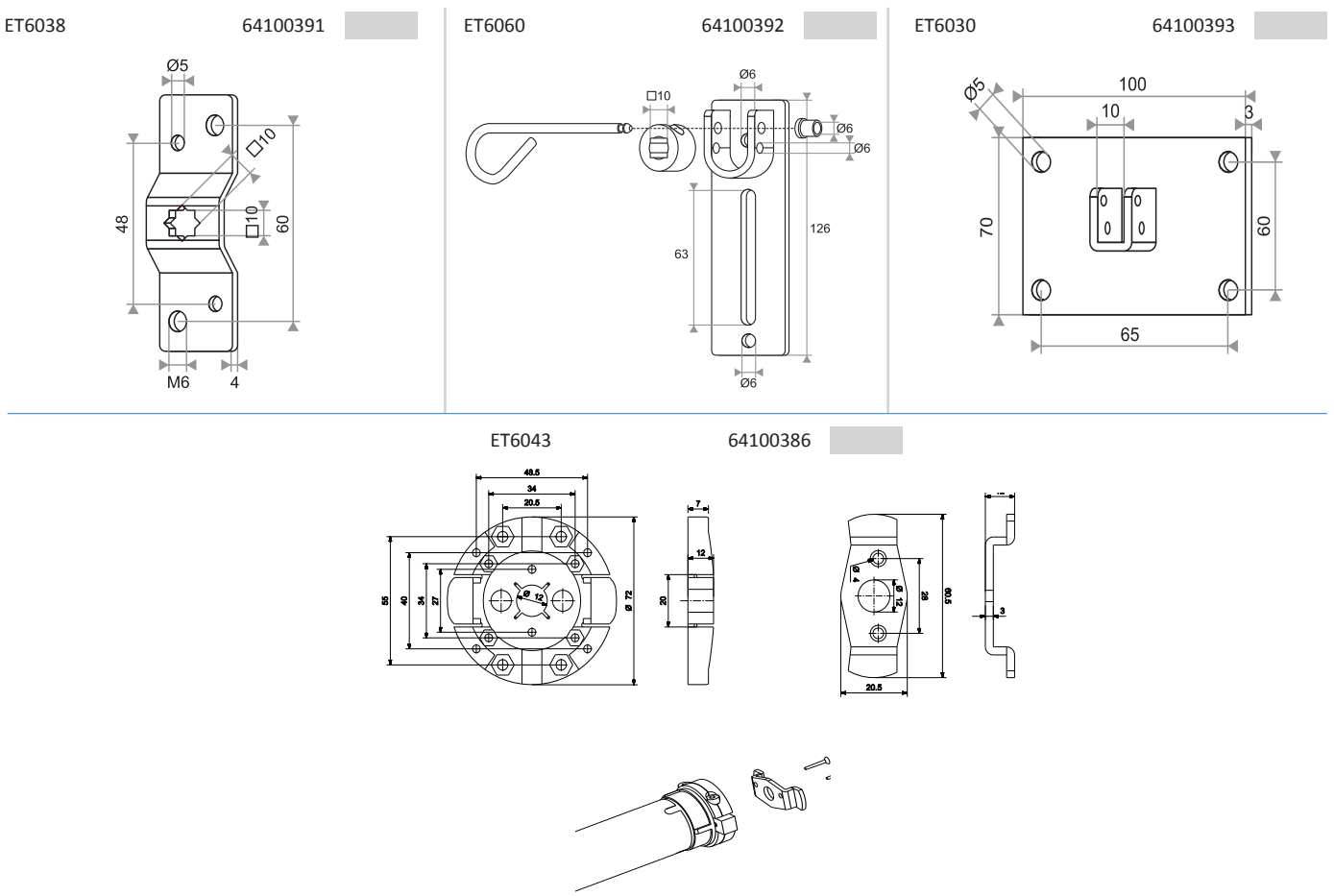

Série EURODRIVE – Adaptateurs / Serie EURODRIVE – Adaptadores

Couple d'adaptateurs pour tube rond
Par de adaptadores para tubo redondo.

Ø Moteur Ø Motor	Ø Tube Ø Tubo	Nom Nombre	Code Código	Prix Precio
35mm	40mm	ED0715	64100427	
35mm	50mm	ED0716	64100459	
45mm	56mm	ED0956	64100448	
45mm	60mm	ED0914	64100383	
59mm	67mm	ED1267	64100377	
59mm	94mm	ED1257	64100375	
59mm	97.3mm	ED1256	64100396	
92mm	94mm	ED3500A	64100424	
92mm	97.3mm	ED3501A	64100422	
92mm	120mm	ED3506A	64100423	
92mm	130mm	ED3515A	64100467	

ED0715

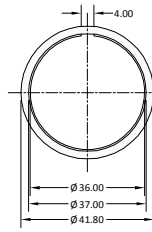

64100427

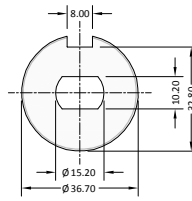

ED0716

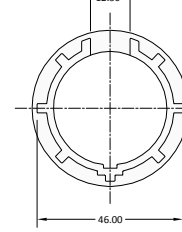

64100459

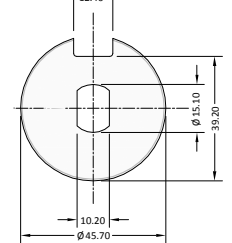

ED0956

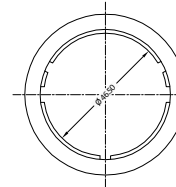

64100448

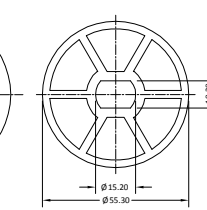

ED0914

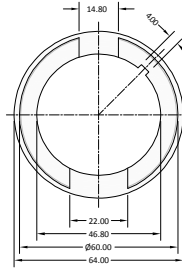

64100383

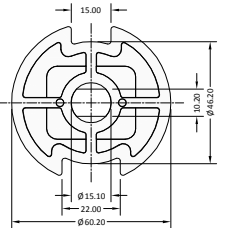

Couple d'adaptateurs pour tube octogonal
Par de adaptadores para tubo octogonal

Ø Moteur Ø Motor	Ø Tube Ø Tubo	Nom Nombre	Code Código	Prix Precio
35mm	40mm	ED0711	64100442	
45mm	50mm	ED0949	64100430	
45mm	60mm	ED0916	64100445	
45mm	70mm	ED0912	64100450	
59mm	70mm	ED1248	64100466	

ED0711

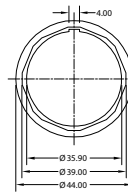

64100442

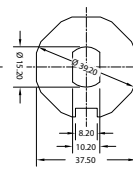

ED0949

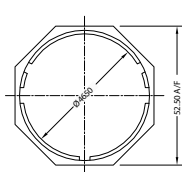

64100430

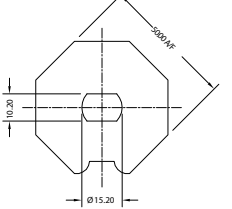

ED0916

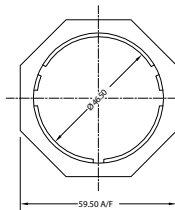

64100445

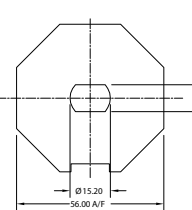

ED0912

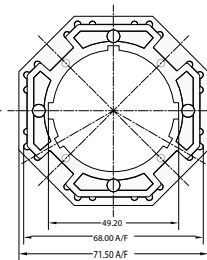

64100450

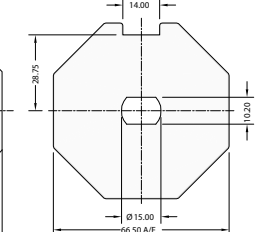

Couple d'adaptateurs pour tube avec ogive
Par de adaptadores para tubo con ojiva.

Ø Moteur Ø Motor	Ø Tube Ø Tubo	Nom Nombre	Code Código	Prix Precio
45mm	70mm(*)	ED0968	64100458	
45mm	70mm	ED0967	64100443	
45mm	75mm	ED0976	64100444	
45mm	75mm(*)	ED0976A	64100380	
45mm	85mm	ED0904A	64100381	
59mm	75mm	ED1272	64100376	
59mm	75mm(*)	ED1275A	64100378	
59mm	78mm	ED1275	64100421	
59mm	85mm	ED1266	64100465	
59mm	85mm(*)	ED1266A	64100379	

ED0968

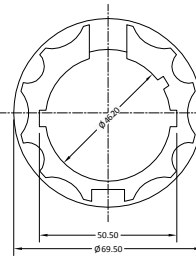

64100458

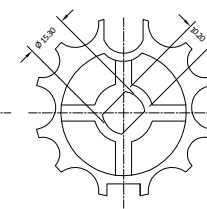

ED0967

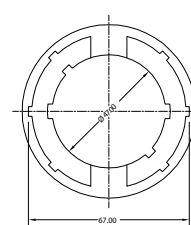

64100443

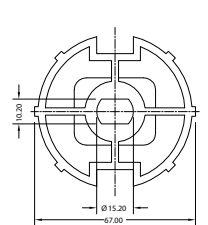

ED0976A

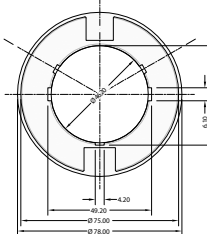

64100444

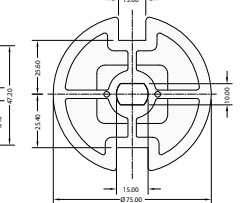

(*) Tube rond ondulé / Tubo redondo ondulado.

Série EUROTEC & EUROPLUS – Accessoires / Serie EUROTEC & EUROPLUS – Accesorios

ET5052

64100454

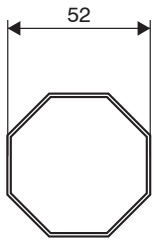

Couple d'adaptateurs pour tube octogonal Ø52mm
Par de adaptadores para tubo octogonal Ø52mm

ET6015

64100457



Couple d'adaptateurs pour tube octogonal Ø60mm
Par de adaptadores para tubo octogonal Ø60mm

ET6025

64100455

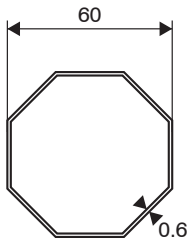

Couple d'adaptateurs pour tube octogonal Ø60mm x 0.6mm
Par de adaptadores para tubo octogonal Ø60mm x 0.6mm

ET7025

64100456

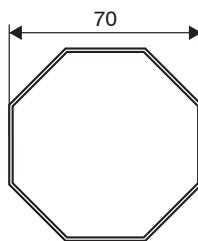

Couple d'adaptateurs pour tube octogonal Ø70mm
Par de adaptadores para tubo octogonal Ø70mm

ET7815

64100451

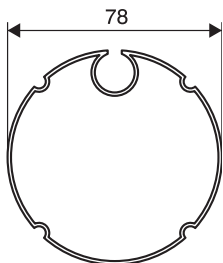

Couple d'adaptateurs pour tube avec ogive Ø78mm
Par de adaptadores para tubo con ojiva Ø78mm

ET7015

64100452

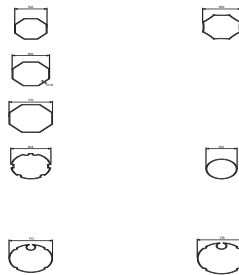

Couple d'adaptateurs pour tube avec ogive Ø70mm
Par de adaptadores para tubo con ojiva Ø70mm